



USS
Designed for switching, control and signalling of auxiliary and power circuits.



Blind



Switch, Switches, Buttons,



Switch with indicator

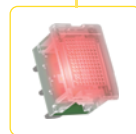

Signals

USS | Controlling and signaling modules

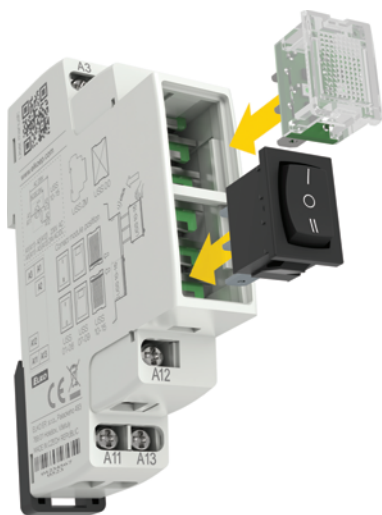

- Independent switch units designed for flexible controlling and switching of power circuits.
- USS - "Do It Yourself" = it is possible to "click into" different types of switches and signalling units into the basic module.
- Units are delivered as components and configured by the user.
- 16 types of units: switches, push buttons, signal lights of different colours including flashing lights units are replaceable also for future (for example when an application is changed, extended, etc...).
- Units are also replaceable in the future (for example when an application is changed, extended, etc...).
- It is possible to place up to two units into one MODULE (for example 2x switch, 2x signalling lights or combinations) = saves space in switch-board panels.
- 1-MODULE (90 x 17.6 x 64 mm/3.5" x 0.7" x 2.5"), DIN rail mounting.
- Operating temperature -20 °C .. +55 °C (-4 °F .. 131 °F).
- M3 screw with clamp terminals.

Connection

Connection of signaling light

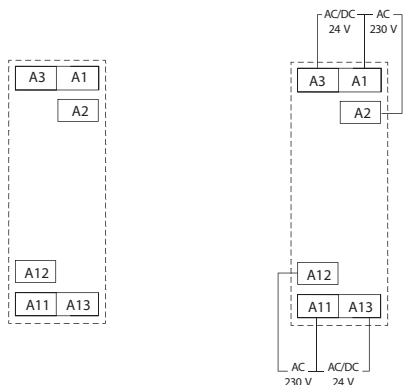

Installing the USS into the module

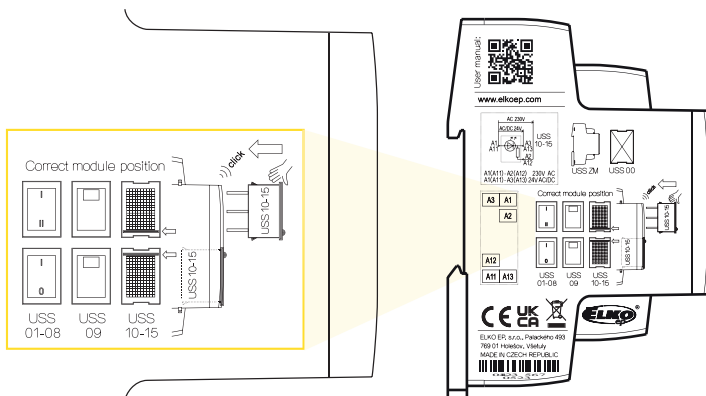

Examples of mounting



USS-01 + USS-03



USS-07 + USS-11



USS-11 + USS-01















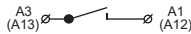

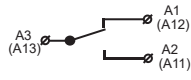

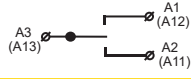

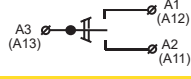

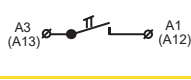

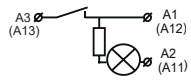

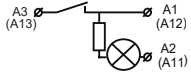
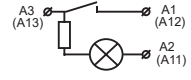

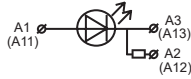
USS-10 + USS-00

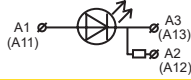

USS-10 + USS-11



USS-07 + USS-00

TYPE DESIGNATION	EAN CODE	CONNECTION	RATED CURRENT/VOLTAGE (FOR SWITCHES) SUPPLY VOLTAGE (FOR SIGNALING LIGHTS)	DIMENSIONS	DESCRIPTION
USS-ZM 	8595188124577	MODULE	-	19 x 17.6 x 64 mm (0.75" x 0.69" x 2.5")	Basic MODULE (housing with terminals and contacts)
USS-00 	8595188124614	BLIND FLANGE	-	21 x 15 x 7 mm (0.83" x 0.59" x 0.28")	Used to fill in an empty position in the front panel
Switches, push buttons					
USS-01 	8595188124621		6A/250 V AC	21 x 15 x 20 mm (0.83" x 0.59" x 0.79")	Switch
USS-02 	8595188124638		10 A/250 V AC	21 x 15 x 20 mm (0.83" x 0.59" x 0.79")	Alternation switch
USS-03 	8595188124645		10 A/250 V AC	21 x 15 x 20 mm (0.83" x 0.59" x 0.79")	Switch with central position
USS-04 	8595188124652		6 A/250 V AC	21 x 15 x 20 mm (0.83" x 0.59" x 0.79")	Switch + push with central position
USS-05 	8595188124669		6 A/250 V AC	21 x 15 x 20 mm (0.83" x 0.59" x 0.79")	Push button with central position
USS-06/S 	8595188124676		10 A/250 V AC	21 x 15 x 20 mm (0.83" x 0.59" x 0.79")	Push button NO
USS-06/R 	8595188136372		10 A/250 V AC	21 x 15 x 20 mm (0.83" x 0.59" x 0.79")	Push button NC
Switches with glow lamp					
USS-07 	8595188124713		6 A/250 V AC	21 x 15 x 20 mm (0.83" x 0.59" x 0.79")	Switch with glow lamp (red, lights up when the switch is turned on - signal glowing lamp)
USS-08 	8595188124720		6 A/250 V AC	21 x 15 x 20 mm (0.83" x 0.59" x 0.79")	Switch with glow lamp (green, lights up when the switch is turned on - signal glowing lamp)
USS-09 	8595188124706		6 A/250 V AC	21 x 15 x 20 mm (0.83" x 0.59" x 0.79")	Switch with glow lamp (yellow, lights up before and after the switch is turned on - indicative glow lamp)
Signaling lights					
USS-10 	8595188124331		A1-A2, AC 230 V A1-A3, AC/DC 24 V	21 x 15 x 14 mm (0.83" x 0.59" x 0.55")	Signaling LED (red)
USS-11 	8595188124348		A1-A2, AC 230 V A1-A3, AC/DC 24 V	21 x 15 x 14 mm (0.83" x 0.59" x 0.55")	Signaling LED (green)
USS-12 	8595188124355		A1-A2, AC 230 V A1-A3, AC/DC 24 V	21 x 15 x 14 mm (0.83" x 0.59" x 0.55")	Signaling LED (yellow)
USS-13 	8595188124362		A1-A2, AC 230 V A1-A3, AC/DC 24 V	21 x 15 x 14 mm (0.83" x 0.59" x 0.55")	Signaling LED (white)
USS-14 	8595188124898		A1-A2, AC 230 V A1-A3, AC/DC 24 V	21 x 15 x 14 mm (0.83" x 0.59" x 0.55")	Signaling LED FLASHING (red)
USS-15 	8595188124379		A1-A2, AC 230 V A1-A3, AC/DC 24 V	21 x 15 x 14 mm (0.83" x 0.59" x 0.55")	Signaling LED (blue)